

## AIKO PV Module Installation Manual

### Dual Glass Module

AIKO reserves the right to change this Manual without prior notice.

Please check the latest version of the Installation Manual in the official website of A

Website: <https://www.aikosolar.com/>

AIKO Dual Glass Installation Manual, Version 4.0, May 2024



Module Type	Applicable module models
Dual Glass	AIKO-Axxx-MAH54Db
	AIKO-Axxx-MAH72Dw
	AIKO-Gxxx-MCH72Dw
	AIKO-Gxxx-GRH66Dw
	AIKO-Axxx-MAH78Dw
	AIKO-Gxxx-GCH66Dw

Table 1: Applicable modules models



- This Installation Manual provides information regarding the installation and safe use of PV power solar modules (hereinafter referred to as “PV modules”) produced by Zhejiang Aiko Solar Technology Co., Ltd. (hereinafter referred to as “AIKO”). Installation and day to day maintenance of modules shall be in accordance with all safety precautions specified in this Manual and local laws.
- Installation module systems requires specialized skills and knowledge, and modules shall be installed and maintained by qualified persons. Please read this manual carefully before installing and using this module. The installers shall be familiar with mechanical and electrical requirements of the system. Please keep this Manual for future maintenance or treatment.

CONTENTS

<b>01 OVERVIEW .....</b>	<b>5</b>
<b>02 LAWS AND ACTS .....</b>	<b>5</b>
<b>03 GENERAL INFORMATION.....</b>	<b>5</b>
3.1 MODULE IDENTIFICATION .....	6
3.2 WIRING METHOD.....	8
3.3 GENERAL SAFETY.....	9
3.4 ELECTRICAL SAFETY .....	10
<b>3.5 HANDLING SAFETY.....</b>	<b>10</b>
3.6 FIRE SAFETY .....	12
<b>04 STORAGE AND TRANSPORTATION INSTRUCTIONS.....</b>	<b>13</b>
4.1 CONSIDERATIONS FOR MODULE TURNOVER AND HANDLING .....	13
4.2 CONSIDERATIONS FOR MODULE TURNOVER AND TRANSPORTATION.....	14
4.3 CONSIDERATIONS FOR MODULE STORAGE AND PLACEMENT.....	14
<b>05 INSTALLATION CONDITIONS.....</b>	<b>15</b>
5.1 LOCATION AND WORKING ENVIRONMENT .....	15
5.2 TILT ANGLE SELECTION .....	16
<b>06 MECHANICAL INSTALLATION.....</b>	<b>17</b>
6.1 GENERAL REQUIREMENTS .....	17
6.2 MECHANICAL INSTALLATION OF DUAL GLASS MODULES .....	18
6.2.1 PV module installation method: Mounting pressure clamps.....	18
6.2.2 PV module installation method: Bolts Mounting .....	18
6.2.3 PV module installation method: Single-axis tracking system installation.....	20
<b>07 ELECTRICAL INSTALLATION.....</b>	<b>23</b>
7.1 ELECTRICAL PERFORMANCE .....	24
7.2 CABLES AND CONNECTIONS .....	25
7.3 CONNECTOR.....	25
<b>08 GROUNDING .....</b>	<b>26</b>
<b>09 MAINTENANCE OF PV MODULES.....</b>	<b>27</b>
9.1 CLEANING.....	27



9.2 VISUAL CHECKS OF THE MODULES.....	28
9.3 CHECKS OF CONNECTORS AND CABLES .....	29
9.4 AIKO TECHNICAL SUPPORT .....	29



## 01 Overview

Thank you very much for choosing the products of Zhejiang Aiko Solar Technology Co., Ltd. (hereinafter referred to as “AIKO”).

This Installation Manual contains important information regarding electrical and mechanical installation which you shall know before installing modules. It also contains some other safety information that you must be familiar with.

This installation manual does not entail any explicit or implicit quality warranty and does not stipulate on compensation schemes for losses, module damages or other costs caused by or related to module installation, operation, utilization and maintenance process. When there is a dispute between the parties about the root -cause of module damage, the IEC 61215-2:2016 static mechanical load test item and the approved maximum static test load should be applied to determine the module quality. AIKO is liable for the losses or expenses incurred only when the module failed above tests.

AIKO reserves the rights for modifying product manual or installation manual without advanced notice. It is recommended to visit our website regularly at <https://aikosolar.com/> for the latest version of this installation manual.

Customer’s failure to install modules according to the requirements listed in this Installation Manual will invalidate the limited product warranty offered to customer. Recommendations in this Manual are provided to improve installation safety, and are based on tests and practical experience. Please provide this Manual to end customers (or consumers) and inform them of all safety, operation and maintenance requirements and recommendations.

## 02 Laws and acts

Mechanical and electrical installations of PV modules shall be executed by referring to the applicable laws and acts, including the electrical act, building act and electrical connection requirements. These requirements vary from one location to another, such as building rooftop installations and onboard applications. They may also vary with mounting system voltage and current property (DC or AC). Please contact your local authority for further details.

## 03 General Information

### 3.1 Module Identification

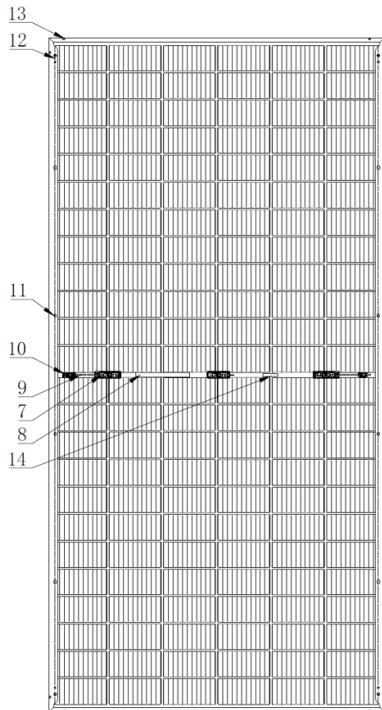

Structural diagram of double-glass modules and component description

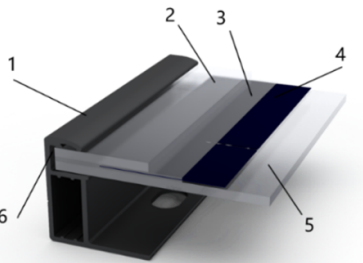

- |                         |                    |
|-------------------------|--------------------|
| 1. Aluminum alloy frame | 8. Nameplate       |
| 2. Front glass          | 9. Cable           |
| 3. EVA                  | 10. Connector      |
| 4. ABC cell             | 11. Mounting hole  |
| 5. Back glass           | 12. Grounding hole |
| 6. Silicone             | 13. Leak hole      |
| 7. Junction Box         | 14. Barcode        |

AIKO PV modules provide Two visual labels:

**Nameplate** Product type, information regarding the rated power, rated current, rated voltage, open circuit voltage, short circuit current under standard test conditions (STC), maximum system voltage and certification mark, etc.

**Serial number** Each individual PV module is identified with a unique serial number which is printed on the barcode and placed into the PV module before lamination. The same serial number can also be found at the side of frame of PV module as well as at the back of PV module.

#### Nameplate

<b>Model:</b> STC: AM=1.5, E=1000W/m <sup>2</sup> T <sub>c</sub> =25°C BNP: 1000W/m <sup>2</sup> +±135W/m <sup>2</sup> BSI: 1000W/m <sup>2</sup> +±300W/m <sup>2</sup> Bifaciality coefficient (η) ♣Voc=xxx ♣Is=xxx ♣Pmax=xxx		Test conditions Maximum Power (Pmax) Voltage at Pmax (Vmp) Current at Pmax (Imp) Open-Circuit Voltage (Voc) Short-Circuit Current (Isc)	STC    BNP xxx W    xxx W xxx V    xxx V xxx A    xxx A xxx V    xxx V xxx A    xxx A	Power Tolerance    ±3% Voc & Isc Tolerance    ±3% Maximum System Voltage    1500 V Maximum Series Fuse Rating    xxx A Operating Temperature    -40°C~+85°C Protection Class    Class II	Isc att    xxx A±3% Min. Design Load    +3600 Pa/-1600 Pa Module T <sub>amb</sub> max    70 °C Connector    See connector information in Constructional Data Form	Web: www.aikosolar.com Zhejiang Aiko Solar Technology Co., Ltd. Add: No. 655, Hoopai Road, Suxi Town, Yiwu 322009 Zhejiang, P.R. China Made in China	
		See connector information in Constructional Data Form					

#### Barcode



**Packaging List:** Packaging list including the information of the PV module type, product serial number, package weight, package dimension as well as cells color classification. To ensure consistency of the overall color of system when the customer use the modules, the box of PV modules is packaged according to the same color of cells and marking the with S1, S2, S3, on the packing list.



Following as a sample:

### AIKO Packaging List

Pallet No.	A223711001		Module Power	625 W	
			Qty	36 PCS	
			Color Code	S2	
Product No.	300100000125		Bin Code	MABR035	
Module Type	AIKO-G625-MCH72Dw	Remark:	Sirius/Polaris		
Product Description	625/A/20BB/2382*1134*30mm/AIKO-JB-xyz-01/AIKO-01C/+350mm/350mm/1.5KV/30A/A223711001				
N.W.	1188 KG	G.W.	1248KG	Package Size	2390*1130*1260mm
S/N:2D		EAN:	UPC:		
			6 976601 55 1163		
Made in China					
NO.	Serial Number	NO.	Serial Number	NO.	Serial Number
1		2		3	
4		5		6	
7		8		9	
10		11		12	
13		14		15	
16		17		18	
19		20		21	
22		23		24	
25		26		27	
28		29		30	
31		32		33	
34		35		36	

## 3.2 Wiring method

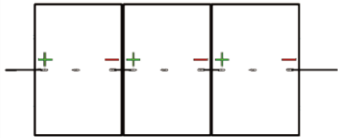
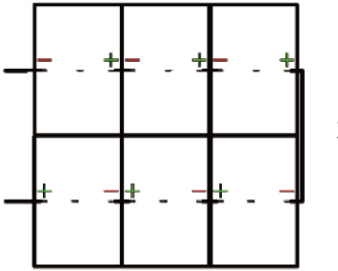
The junction box of AIKO PV modules is located in the middle position. Please refer to the table below for how to connect AIKO PV modules in series.

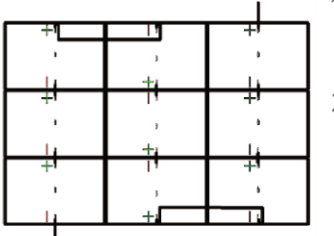
Position of junction box	Module mounting type	Connection diagram	
	Mounting on the long side, single row		Horizontally adjacent modules are directly connected at the shortest distance or, if the wire is too long, by placing the wire into the secondary beam.
	Mounting on the long side, double rows		<ol style="list-style-type: none"> <li>1. Horizontally adjacent modules are directly connected at the shortest distance or, if the wire is too long, by placing the wire into the secondary beam;</li> <li>2. Connections between adjacent rows of modules shall be designed and installed by considering the opposite polarity on the same side as shown below. Adjacent modules are side connected by routing the wire through a duct instead of using an uncovered wire.</li> </ol>
	Mounting on the short side, single row		In vertical installation, connections between vertically adjacent modules are designed and installed with opposite polarities between adjacent modules as shown and the extension line can be placed into the secondary beam.
	Mounting on the short side, multiple rows		<ol style="list-style-type: none"> <li>1. Vertically adjacent modules as shown below are connected at the shortest distance;</li> <li>2. Connections between adjacent columns of modules shall be designed and installed by considering the opposite polarity on the same side as shown below. Adjacent modules may be side connected by placing the wire into the secondary beam.</li> </ol>



## 3.3 General Safety

AIKO PV modules are designed to operate in application according to IEC standards IEC-61215 and IEC-61730. PV modules are designed with safety Class II and fire class rating C.

- Before to handle and install AIKO PV modules, read carefully and understand this Installation Manual. If you need any explanation, contact AIKO (aikosolar.com).
- Always use appropriate protections such as insulated tools, safety helmets, insulating gloves, safety belts and safety insulating shoes when handling the PV modules whether it is or not connected to the system. Please use appropriate electrical safety tools when you need to install, ground, connect, clean or handle the PV modules.
- PV modules generate DC electrical energy when exposed to sunlight or other light source. Improper contact with live parts of the module (e.g. connectors) can result in burns, sparks, and lethal shock
- Observed local laws and regulations for module installation and obtain a building license or other qualifications where necessary.
- PV modules shall be installed by qualified persons who have specialized skills and knowledge and are familiar with the mechanical and electrical requirements of the system. Potentially harmful risks during installation, including electrical shock, shall be identified in advance.
- Rooftop systems can only be installed on the roofs which have passed the evaluation of construction experts with formal, full structural analysis results, where necessary.
- Observed the safety regulations for all mounting components. For example, wires and cables, connectors, inverters and batteries.
- Artificially concentrated sunlight shall not be directed onto the PV module.



## 3.4 Electrical safety

Please strictly follow the electrical safety precautions below to avoid any form of electrical safety accident.

- PV modules can generate DC voltage >30V under standard test conditions (STC), take care to avoid direct contact. When installing PV modules, wear protective helmets, insulating gloves, and rubber shoes. Do not install PV modules without security precautions.
- Do not drill holes in the frame, this action may cause PV module insulation failure.
- Do not make electrical connection by means other than connectors.
- Broken PV modules have the risk of electric shock and fire that must be replaced immediately.
- PV modules must be installed when it is electrically safe.
- Avoid touching PV modules as the surface and frame of the modules may be hot and there is a risk of burns or electric shock. The voltage connected in series of the PV modules must not exceed the maximum withstand voltage value.
- Do not connect or disconnect the PV module when there is a current leakage of module or when there is an external current present. Please disconnect the faulty PV modules with safety protection.

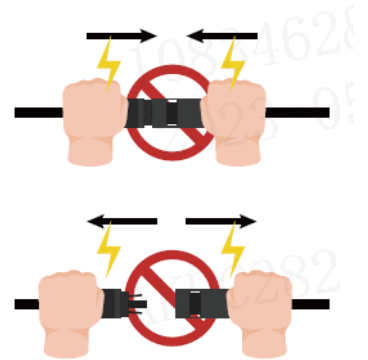

## 3.5 Handling safety

- Standing, stepping, sitting, walking or jumping directly on the PV module package or PV module is prohibited.



- Do not place heavy objects on the PV module.



- Do not connect the positive and negative anode cables of the same PV module together.
- Do not open the carton box before the PV modules arrive at the location, keep the packing box in a ventilated, dry environment.
- During the transportation, please refer to Chapter 4 – Storage and Transportation instructions. Any inappropriate handling and storage can result in breakage of glass or loss of electrical property, and consequently loss the use value of PV modules.
- Take careful when install PV modules. In any case, it is forbidden to lift the PV module by lifting the junction box or cable. At least two or more than two operators must hold the edges of the PV module with both hands.
- Do not try to dismantle the PV modules or remove any nameplates or components of PV modules.
- Do not apply paint or other adhesives to PV module top surface.
- Do not damage or scratch the glass on front side and back side of PV modules.
- Do not drill holes on the frame of PV modules, which may reduce frame loading capacity and lead to frame corrosion and invalidation of the limited warranty provided for customers.
- Do not scratch anodized coating of aluminum alloy frame except for grounding connection. Scratch may lead to frame corrosion and reduce frame loading capacity and long-term reliability.
- Do not repair or modify the PV module on your own.

## 3.6 Fire safety

- Please refer to local laws and regulations before installing any PV modules and observe their building fire safety requirements.
- Rooftop installations shall be placed over fire resistant roof coverings appropriate for this rating, and adequate ventilation shall be provided between the back glass and the mounting surface. The roof structure and PV module mounting method will affect the fire safety performance of the building. Inappropriate installation can lead to fire risks.
- To guarantee roof fire rating, the distance between PV module frame and roof surface must be greater than 10cm.
- Please use the appropriate PV module accessories, e.g., fuses, circuit breakers and ground connectors, according to local laws and regulations.
- Please do not apply PV modules in where exposed inflammable gases are nearby.

## 04 Storage and Transportation Instructions

### 4.1 Considerations for PV Module Turnover and Handling

Upon arrival of the PV modules,

Please check the carton box is in good condition, and check whether the PV module type and quantity on the outer packaging are consistent with the delivery order. If anything wrong is observed, please contact AIKO logistics and sales staff immediately.

#### 1. Crane unloading:



When unloading PV modules by crane, please choose and use specialized tooling according to the weight and size of the pallet.

Please adjust the position of the sling to keep the modules steady.

- To ensure the safety of the PV module, wooden sticks, boards or other fixtures of the same width as the outer packing cases should be used on the upper part of the box to prevent the sling from squeezing the pallet and damaging the PV modules.
- Please operate the spreader at a constant speed, when the lifting is close to the ground, place the box gently in a relatively flat ground.
- Do not unload PV modules under the weather conditions of wind more than 6 class (in Beaufort scale).



#### 2. Forklift unloading:



The loading dock should be as the same height as the underside of the carrier.

Keep the straight-line speed of forklift within 5km/h and the turning speed within 3km/h. Please avoid sudden stop and rapid start.

- If the carton box blocks the sight of the forklift driver, it is recommended to drive backwards during the fork-lifting, and arrange for special supervision and command to prevent bumping into people or items causing personal injury or damage to the PV modules.

## 4.2 Considerations for PV Module Turnover and Transportation

- When using forklift to transport PV modules, please ensure that the fork length meets the requirements to avoid PV module tilting due to uneven force.
- When opening the carton box, please place the PV modules to be unpacked at a distance of 20-30cm from the wall or another torr of PV modules, and then remove the torr. After removing the cable tie of the fixed PV modules, slowly lean the PV modules against the wall or another torr of PV modules to prevent them from falling.
- Please handle the installation PV modules gently during transportation. Do not lift the PV modules by pulling the junction box or cables under any circumstances. Two or more people must hold the edges of the PV modules with both hands.

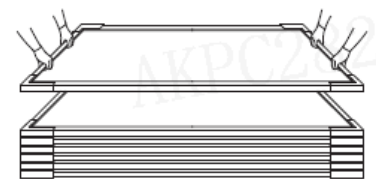
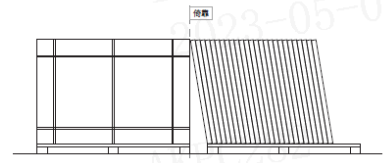
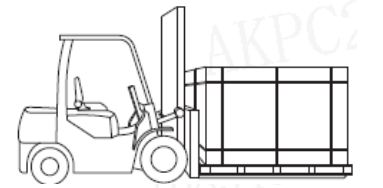

## 4.3 Considerations for PV Module Storage and Placement

- Please store the packing box of PV modules in a clean, dry place with relative humidity below 85%RH. The storage temperature should be between -20°C and 50°C. When storing PV modules for a long time, do not place the two boxes of PV modules on top of each other.
- In any circumstances, keep the junction box and cables of the PV modules clean and dry.
- Store PV modules in a ventilated, rainproof, dry place. If placed outdoor, please fully cover the PV modules and pallets with a rain protection and take moisture-proof measures on pallets and cartons to prevent collapse and moisture ingress.
- For the storage of scattered PV modules, please stack the vertical PV modules flat on the empty torr. The first PV module should be placed with the glass side up, and the following ones placed with the glass side down. (A maximum of 22 modules can be stacked for 54-cell types, and 16 modules for 72-cell types).

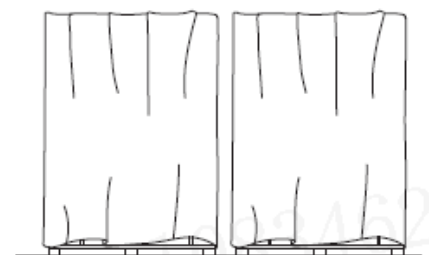

- For long-term storage, do not remove the original package and keep the wrapping film and carton box in a good condition. It's recommended to place PV modules in a standard warehouse for long-term storage and conduct regular inspections. Once there is an abnormal tilt, please take enforcement measures in time.

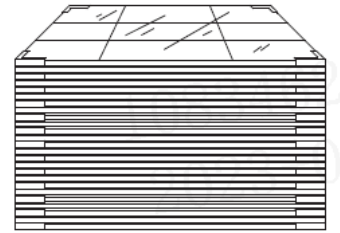

## 05 Installation Conditions

### 5.1 Location and working environment

- PV modules are recommended to be installed in a  $-20^{\circ}\text{C}$  to  $50^{\circ}\text{C}$  environments, with an extreme working ambient temperature of  $-40^{\circ}\text{C}$  to  $85^{\circ}\text{C}$  and a humidity less than 85%RH.
- Do not install PV modules in locations or areas where there is a risk of flooding, and do not install or place PV modules near open flame or flammable materials.
- PV modules can be installed at a distance of 50m to 500m away from the seashore. In the case when the PV modules are installed within 50m to 500m distance from the seashore, the frame and related components need to be treated with anti-corrosion (Except for products that can be used in offshore or salt-affected areas, as confirmed and supplied by AIKO).
- For rooftop installations, leave a safe working area between the edge of the roof and the external edge of the PV module array.
- For rooftop installations, check the roof loads and make a construction organization plan to meet the applicable standards.
- PV modules shall be positioned to receive adequate sunlight and avoid shading the PV module surfaces in part or in whole (by trees, buildings etc.).
- PV modules shall be installed in a well-ventilated position to ensure adequate air circulation on the back and sides of the PV module and allow immediate dissipation of heat produced during PV module operation, poor heat dissipation of the PV modules will decrease the output power and affect the overall power output of PV modules.
- When PV modules suffer high wind or snow pressure, supports and fixings shall be designed according to local design standards to keep external loads within the maximum mechanical strength that PV modules can withstand.

- In areas (coastal areas, factories, volcanic areas, farmlands) exposed to salt fog, sulfide or ammonia gas, corrosion can occur at the connection between the PV module and the racking or at the ground connection. Anti-corrosive materials (e.g., stainless steel or aluminum materials) must be used in contact with PV modules and the mounting position must be protected against rust (Except for products that can be used in offshore or salt-affected areas, as confirmed and supplied by AIKO).
- After the PV modules are installed, measures such as grounding must be taken to ensure that the PV modules are protected against lightning strikes.



## 5.2 Tilt angle selection

Tilt angle of PV module is the angle between the PV module and the horizontal ground. Different projects shall choose different installation inclination angles according to local conditions.

- All PV modules in the same array shall be same orientation and angle. Different orientations and angles will result in different total solar irradiation absorbed by PV modules, leading to output mismatch that degrades system operating efficiency.
- In order to achieve the maximum annual generating capacity, the optimal orientation and inclination of PV modules in the installed area should be selected. When the surface of the PV module is perpendicular to sunlight, the output power reaches the maximum output value. AIKO recommend the installation angle shall not less than  $10^{\circ}$ .
- The optimal tilt angle of PV arrays shall be designed by taking into account the multi-year average monthly irradiance, direct irradiance, scattering irradiance, wind speed and other climate conditions at the location. PV modules should be tilted at an angle to receive the maximal annual irradiance. Angles shall be selected by considering natural conditions such as local wind load, snow load and avoidance of water and dust collection on module surfaces.

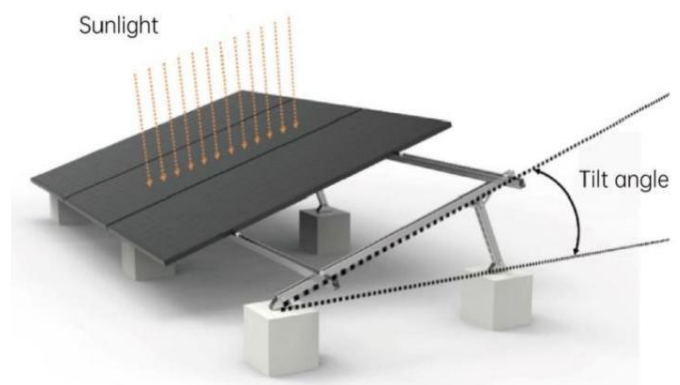

For details on the optimal tilt angle for installation, refer to consult a reliable local



## 06 Mechanical Installation

### 6.1 General requirements

- Make sure that the PV modules are properly installed and the mounting structure are adequately fastened. PV module mounting system shall be constructed of anti-corrosive, ultraviolet resistant materials.
- Installation bracket system shall be tested and inspected by the third-party testing institution with static mechanical analysis capacity in accordance with local national standards or international standards.
- In regions with heavy snowfall in winter, adjust the height of the mounting system so that the lower edge of the PV module is not covered by snow. In addition, ensure the lower part of PV module is not in the shadow of plants, trees.
- For rooftop installations, the minimum gap between the PV module frame and the roof shall be 10cm which is good for air circulation to achieve better performance of PV module.
- The minimum mounting distance between adjacent PV modules is 10mm.
- Make sure that backside of PV modules will not be in contact with bracket or building structures that can pierce into the inside of the PV modules, especially when the PV module surface is imposed by pressure.
- PV modules can be installed horizontally or vertically. When installing the PV modules, be cautious not to block the drain hole of the frame.
- The PV module loads described herein are test values. According to IEC 61215-2016 installation requirements, when computing the corresponding maximum design load, a safety factor of 1.5 need to be considered in compliance with the local laws or regulations.
- In additions, project design loads must be based on project location, climate, mounting structure and applicable standards. Design loads are determined by mounting suppliers. Please observe both the local laws and regulations and the instructions of structural engineers.

## 6.2 Mechanical Installation of Dual Glass PV Modules

AIKO dual glass PV modules can be connected to the racking system using pressure clamps and bolts. PV Modules must be mounted as recommended and illustrated below. Other mounting configurations may be used provided that consultation is made with, and prior written consent is received from AIKO. Failure to do so will invalidate our warranty.

### 6.2.1 PV Module Installation Method: Mounting Pressure Clamps

Specialized pressure clamps are used to mount modules as shown below.

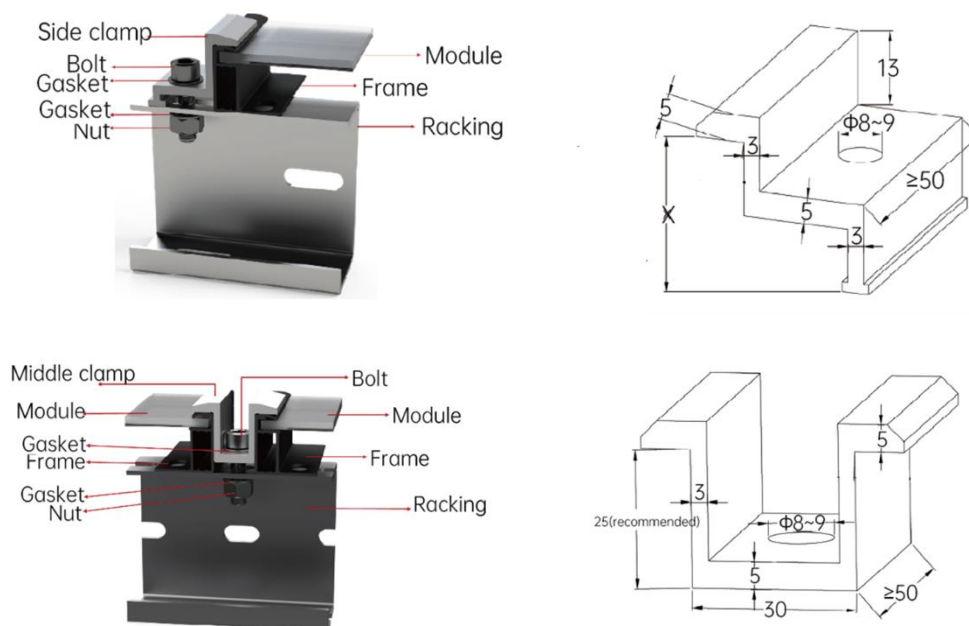

- Under no circumstances should the clamp touch the glass or deform the frame. Be sure to avoid shadowing effect from the pressure clamp.
- Be sure that pressure clamps will not fail due to deformation or corrosion while the entire PV module is under load. Pressure clamps  $\geq 50\text{mm}$  in length and  $\geq 3\text{mm}$  in thickness are recommended. The overlapped distance between the pressure clamp and the PV module frame, D, shall be at least 8mm but no more than 10mm.
- When choosing clamp-mounting, please be sure to use at least four clamps on each PV module. Depending on the local wind and snow loads, if excessive pressure load is expected, at least six clamps should be required to ensure the PV module can bear the load (more details, please contact AIKO technical personnel).
- Do not drill additional holes or modify the PV module frame. Doing so will void the PV

module' s warranty.

- Use appropriate corrosion-proof fastening materials. All mounting hardware (bolts, spring washers, flat washers, nuts) should be hot dip galvanized or stainless steel. Install and tighten the PV module clamps to the mounting rails using the torque stated by the mounting hardware manufacturer.

Note that:

M8 bolt tightening torques must be within 16~20Nm (11.8~14.75 ft-lbs), respectively, depending on bolt classes. For the bolt grade, the technical guidelines from the fastener suppliers should be followed. Different recommendations from specific clamping hardware suppliers should prevail.

Dual glass PV modules can be installed using pressure clamps. Following are the installation diagram and corresponding loads. Here, L stand for long side of PV module, W stand for short side of PV module, black shadowing area stand for the installation area of the middle of clamp. Distance and length are provided in mm; pressure is provided in Pa.

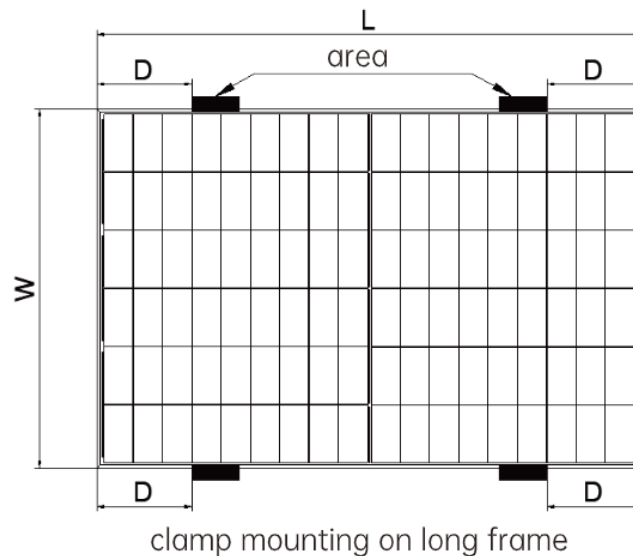

Installation Method	Module Model	Module Size L*W (mm)	Load (Pa)	Installation Range D	
				30mm Frame	33mm Frame
Clamp mounting on long frame	AIKO-A***-MAH54Db	1757*1134	+5400/-2400	295≤D≤395	/
	AIKO-A***-MAH72Dw	2278*1134	+5400/-2400	430≤D≤530	/

	AIKO-G***-MCH72Dw AIKO-G***-GRH66Dw	2382*1134	+5400/-2400	$500 \leq D \leq 600$	/
	AIKO-A***-MAH78Dw	2465*1134	+5400/-2400	$550 \leq D \leq 650$	/
	AIKO-G***-GCH66Dw	2384*1303	+5400/-2400	/	$415 \leq D \leq 515$

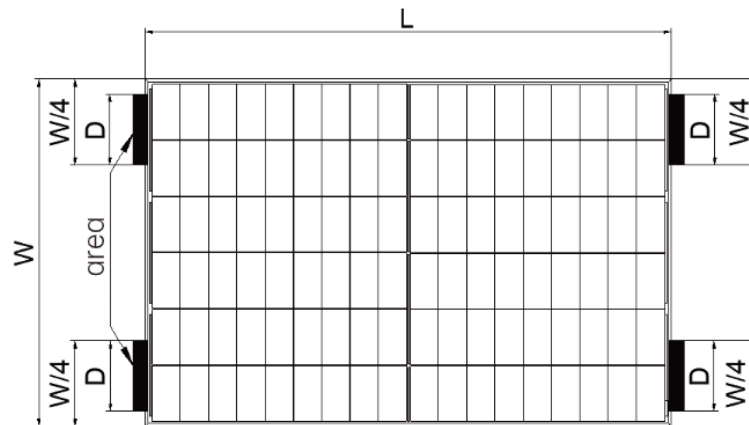

clamp mounting on short frame

Installation Method	Module Model	Module Size L*W (mm)	Load (Pa)	Installation Range D
				30mm Frame
Clamp mounting on long frame	AIKO-A***-MAH54Db	1757*1134	+1600/-1600	$100 \leq D \leq 240$

Note:

1. The above data is based on the static load requirements of IEC61215 standard.
2. ''/'' identifies products without this frame.

## 6.2.2 PV Module Installation Method: Bolts Mounting

Using bolts to secure the PV module on the bracket through the mounting holes at the back of PV module's frame. PV modules come standard with 4 or 8 mounting holes, matching M8 bolts, as figure below:

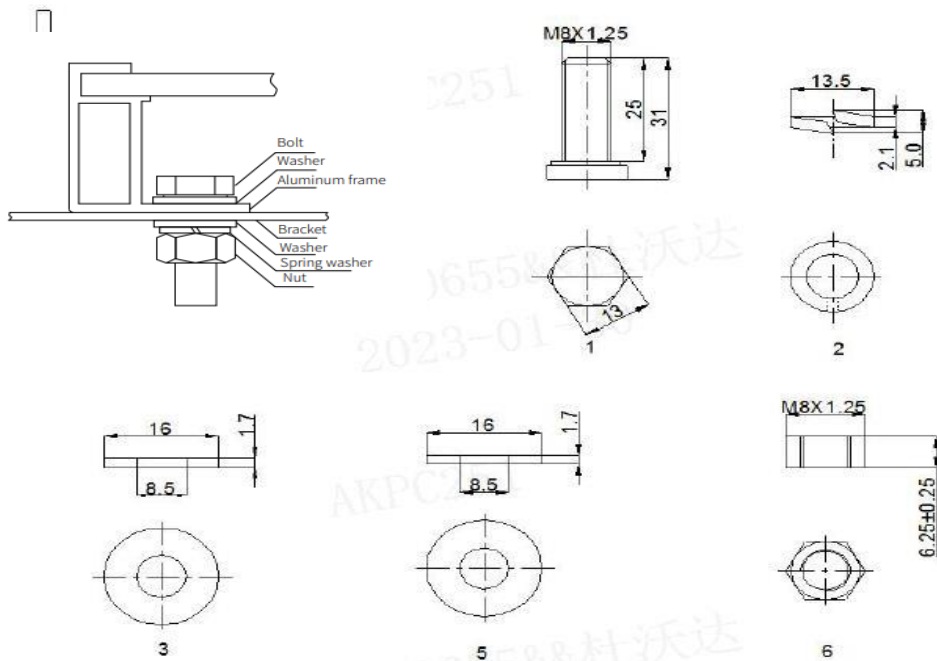

Accessories	Model	Accessories	Model
Bolt	M8*1.25	Bolt	M6*1
Spring washer	8	Spring washer	6
Washer	2 pcs, thickness 1.5mm and outside diameters = 16mm	Washer	2 pcs, thickness 1.5mm and outside diameters = 12-16mm
Nuts	M8	Nuts	M6

It is important to ensure the bolts do not fail due to deformation or corrosion during the overall load of the PV module. AIKO recommend the thickness of washer should  $\geq 1.5\text{mm}$  and use M8 and M6 bolt tightening torques must be within 16~20Nm (11.8~14.75 ft-lbs) and 6~9Nm (4.5~6.6 ft-lbs), respectively, depending on bolt classes. For the bolt grade, the technical guidelines from the fastener suppliers should be followed. Different recommendations from specific clamping hardware suppliers should prevail.

Dual glass PV modules bolt mounting diagram and corresponding loads as below diagram, unit in

Pa.

					
Module Model	Module Size [mm]	Load [Pa]			
		400mm hole	790mm hole	1100mm hole	1400mm hole
AIKO-A***-MAH54Db	1757*1134*30	/	/	+5400/ -2400	+5400/-2400
AIKO-A***-MAH72Dw	2278*1134*30	+2400/ -2400	/	/	
AIKO-G***-MCH72Dw AIKO-G***-GRH66Dw	2382*1134*30	+2400/ -2400	+3600/ -2400	/	

Table 6: Dual glass modules Bolt mounting diagram and corresponding loads, transversal (D)

Module Model (Width of the C-side of the frame 30/15mm)	Module Size [mm]	400mm hole	790mm hole	1400mm hole
AIKO-A***-MAH78Dw	2465*1134*30	/	+3600/-2400	+3600/-2400
Module Model (Width of the C-side of the frame 28/11mm)	Module Size [mm]	400mm hole	1200mm hole	1600mm hole
AIKO-A***-MAH78Dw	2465*1134*30	/	+3600/-2400	+3600/-2400
Module Model	Module Size [mm]	400mm hole	790mm hole	1400mm hole

AIKO-G***-GCH66Dw	2384*1303*33	/	/	+5400/-2400 Tips: (the beam perpendicular to the short frame, +3600/-2400)
-------------------	--------------	---	---	---

Note:

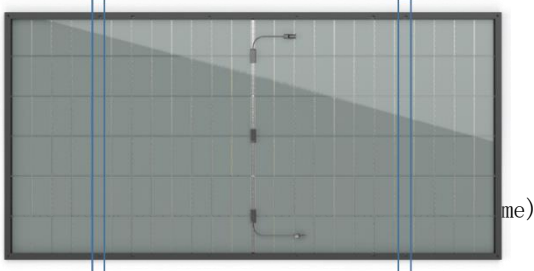
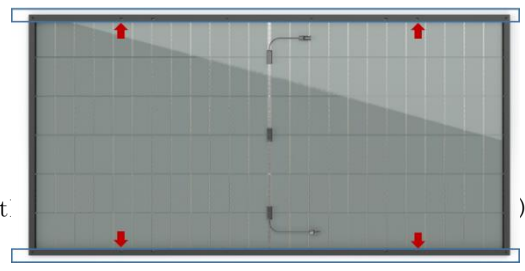
1. The above data is based on the static load requirements of IEC61215 standard.
2. ''/'' identifies products without this frame.

## 6.2.3 PV Module Installation Method: Single-axis Tracking System Installation

AIKO 72 type modules come with standard four mounting holes matching M8 bolts (790mm and 1400mm mounting holes); 72 type modules have an additional four mounting holes matching M6 bolts (400mm mounting holes), used for matching Tracking system product such as NEXTracker. Using bolt to install the PV module on the bracket through the mounting hole at the back of the PV module's frame. Installation details as below:

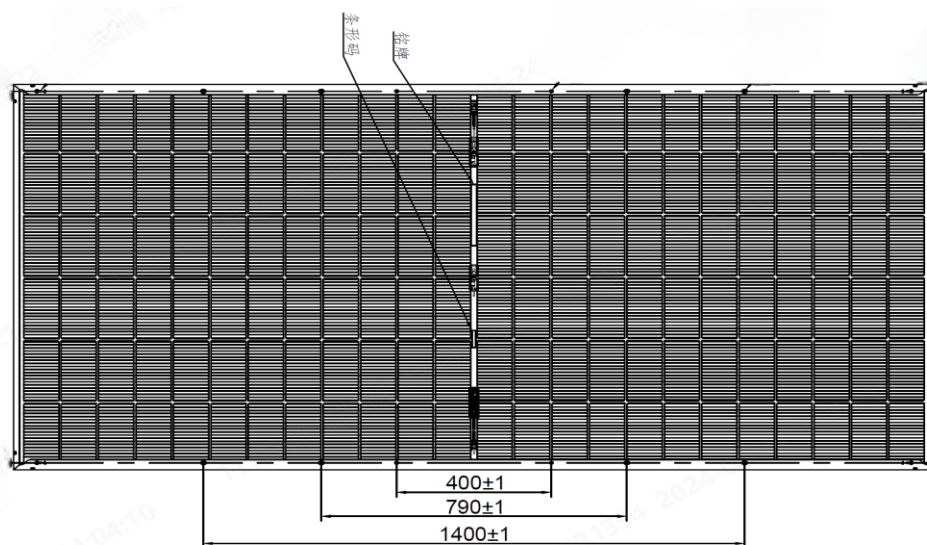

Module Model	Module size L*W*H(mm)	400mm mounting holes	790mm mounting holes	1400mm mounting holes
AIKO-A***-MAH72Dw	2278*1134*30	+2400/-2400	+2800/-2600	+3000/-2600
AIKO-G***-MCH72Dw	2382*1134*30	+1800/-1800	+2600/-2600	+3000/-2600

## 07 Electrical Installation

### 7.1 Electrical Performance

There are tolerances between the rated values of the electrical performance under STC and measured values. Including  $I_{sc}$ ,  $V_{oc}$  and  $P_{max}$  under STC (1000 W/m<sup>2</sup> Irradiance, a cell temperature of 25 °C and an AM1.5).

When PV modules are in series connection, the string voltage is sum of every individual PV module in one string. When PV modules are in parallel connection, the current is sum of the individual PV modules as shown in below. PV modules with different electric performance models cannot be connected in the same string.

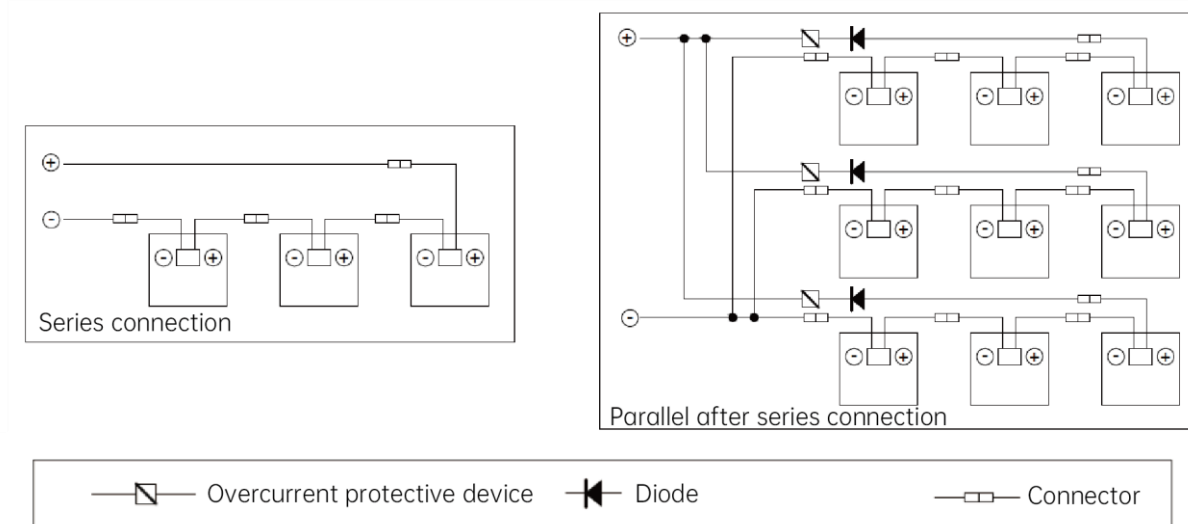

If the PV module is passed through by a reverse current greater than the maximum fuse current of the PV module, the PV module shall be protected with an over current protector of the same specification. If more than two strings are connected in parallel, each PV module string shall be protected with an over current protector as shown above.

The string voltage must not exceed the maximum voltage that the system can withstand or the maximum input power of the inverter or other electrical devices installed in the system. To ensure this, the open circuit voltage of the array shall be calculated at the minimum expected ambient temperature at that location. The following formula may be used:

$$\text{Maximum system voltage} \geq N \times V_{oc} \times [1 + \beta * (T_{min} - 25)]$$

Where:

N—number of modules connected in series



$V_{oc}$ —open circuit voltage of each module (refer to product nameplate or specification) [V]

$\beta$ —thermal coefficient of open circuit voltage for the module (refer to the specification) [ $^{\circ}\text{C}^{-1}$ ]

$T_{min}$ —lowest ambient temperature [ $^{\circ}\text{C}$ ]

## 7.2 Cables and Connections

PV module's junction boxes with the IP68 protective level and composed of connected cables and IP68 connectors. The PV module has a positive and a negative PV connector connected into the junction box and a plug-and-play connector connected at the other end. Using the positive connector of the module to connect the negative connector of the adjacent module connects the two modules in series. Use specialized solar cables and appropriate connectors according to local electrical and installation standards, codes and regulations at the location, and ensure that the electrical and mechanical properties of the cables are good.

AIKO PV modules use specialized PV cables which have a cross sectional area of  $4\text{ mm}^2$  and are ultraviolet resistant. AIKO recommends that all cables are run in appropriate conduits and sited away from areas prone to water collection. AIKO recommend use copper cables with a minimum cross sectional area of  $4\text{mm}^2$  which are rated for  $90^{\circ}\text{C}$  and are UV resistant shall be used as PV connecting lines. The minimum bending radius of the cable is  $43\text{mm}$ .



## 7.3 Connector

- Take care to keep the connectors dry and clean. Make sure that the connector nuts are tightened before making any connection. Do not connect while the connectors are wet or otherwise abnormal. As connectors provide IP68 protection only when the positive and negative poles are fully mated, please connect PV modules as soon as possible after installation or take proper steps to prevent water vapor and dust from coming into the connector.
- Avoid exposing the connector to direct sunlight and water. Avoid exposing the connector

directly to ground surface or roof.

- Make sure that all electrical connections are secure. Incorrect connection can result in electrical arcing and shocks.
- Do not mate different models of connectors together.



## 08 Grounding

PV modules are designed with an anodized anticorrosive aluminum alloy frame as a rigid support. PV module frames must be grounded to ensure safe use and protect the PV module against lightning and electrostatic damage. Grounding must be made with the grounding device in full contact with the interior of the aluminum alloy and penetrating the oxide film on the frame surface.

Grounding devices include grounding screws, flat washers, puncture gaskets and grounding wires. All these items shall be constructed of stainless steel except grounding wires. Grounding wires shall be copper wires. Grounding conductors shall be connected to the ground through an appropriate grounding electrode. Third-party grounding devices meeting local electrical installation standards at the location may be used for grounding AIKO PV modules. Grounding device shall be installed according to the operation manual provided by the manufacturer.

Following is the recommended grounding method:

- There are  $\varnothing 4.2$  mm grounding holes on surface C of the PV module frame. Use a separate

grounding wire and accessories to connect the aluminum alloy frame of PV modules and connect the grounding wire to the ground. We recommend using M4×12 mm grounding bolts accompanied by M4 nuts, star washers and flat washers.

- We recommend torquing grounding bolts to 3~7Nm and using 4mm<sup>2</sup> copper wires as grounding wires.
- Unused PV module mounting holes on the frame may also be used for grounding purposes.
- Connection mode: The star washer, flat washer, and ground wire are placed in sequence, threaded through the ground hole using screws, and tightened to secure the adjacent PV modules.

Components

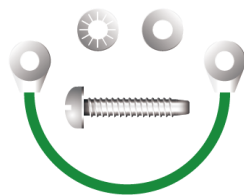

Sketch map

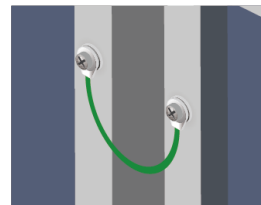

We recommend using the following method to ground correctly, as shown in the figure.

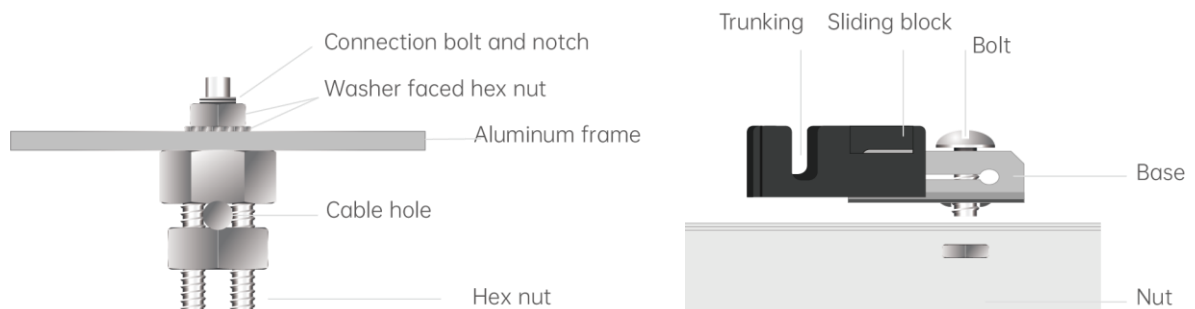

## 09 Maintenance of PV modules

PV modules shall be inspected and maintained on a regular basis, especially within the warranty period, which is an obligatory responsibility of the user. Any damage or other visible abnormalities of the PV module shall be reported to AIKO customer service ([cs@aikosolar.com](mailto:cs@aikosolar.com)) upon discovery.

### 9.1 Cleaning

The power output of PV modules is related to incident light intensity and can be reduced by dust collection or other shadings. Dirt on PV modules must be cleaned up immediately.

The cleaning frequency depends on the degree of dirt collection. PV modules installed at an adequate tilt angle will allow rainwater to clean the PV module surfaces, thereby reducing the cleaning frequency.

We recommend cleaning the glass surface of the PV module with a clear water-netted sponge. Do not clean PV modules with a detergent containing acid or alkali. Do not clean PV modules with a hair brush or other rough surface tools.

We recommend cleaning PV modules in the early morning or late afternoon or other periods of time when the light is weak and the PV module temperature is comparatively lower.

## Method A: High Pressure Water Cleaning

Water quality requirement

- PH: 6-8
- Water hardness - calcium carbonate concentration:
- Recommended use of soft water cleaning;
- Recommended maximum water pressure is 4MPa (40bar)



## Method B: Wet Test Cleaning

- If there is too much stain on the surface of the PV module, it's recommended to carefully use an insulating brush, sponge or other soft cleaning tool.
- Ensure that any brushes or agitating tools are made of insulating material to minimize the risk of electric shock and that they do not scratch the glass or aluminum frame.
- For oil stains, it's recommended to use an environmentally friendly cleaner.

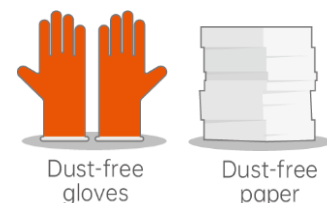

## Method C: Robot Cleaning

If the cleaning robot is used for dry cleaning, the brush material is required to be soft plastic, so that the glass surface and aluminum alloy frame of the PV module will not be scratched during and after cleaning. The weight of the cleaning robot should not be more than 40kg, the PV module damage and power degradation caused by improper cleaning with the cleaning robot are not covered by the warranty of AIKO.

## 9.2 Visual Checks of the PV Modules

Visually checks for visual defects on modules, such as:

- Whether the PV module glass is broken
- Whether the junction box is damaged or the cable is broken

- Whether the PV module is shaded by foreign matter or shadows
- Check whether the bolts fixing the PV module to the racking are loose or corroded and adjust or replace them if necessary
- Check whether the PV modules are well-grounded.

## 9.3 Checks of Connectors and Cables

It is recommended to perform preventive examinations every six months, such as:

- Whether the connectors are properly sealed and the cables are properly fastened
- Whether the sealant of the junction box is cracked.

## 9.4 AIKO Technical Support

In order to request Technical Support:

- Collect evidences of the issue as (a) photos and (b) measurements.
- Be prepared to show the purchase invoice and module serial number.
- Contact your Installer.





Email: [cs@aikosolar.com](mailto:cs@aikosolar.com) (Customer Service)

Web: [www.aikosolar.com](http://www.aikosolar.com)

Rev: V4.0